

Leeds City Council
Data Protection
Practitioner
Day Two

Tim Turner
October 31st 2022

2040

1

Transparency

2

KEY IDEAS

- Concise
- Transparent
- Intelligible
- Easily accessible
- Clear and plain language

3

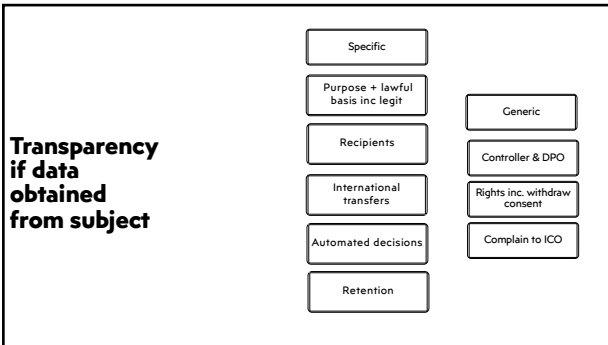

4

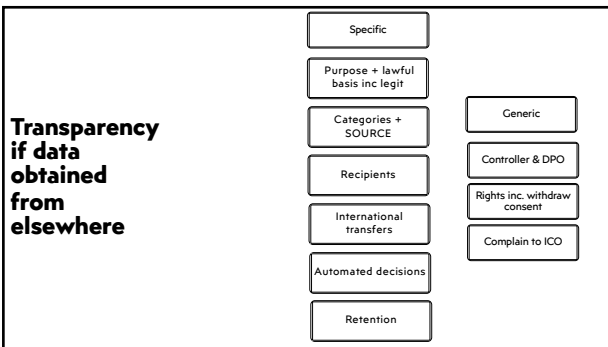



5



6

Deleted vs archived

-  Archived / back-up data is in scope
-  ICO says deleted data isn't covered
-  ICO will not enforce on failure to reconstitute deleted data

7

What makes a valid request?

8

Process

Request for their data	No requirement for written request
Proof of ID	More detail?

9

Process

Valid

Proof of ID

No requirement for written request

More detail?

10

Process

Request for their data

Proof of ID

No requirement for written request

More detail?

11

CLOCK DOES NOT START

12

Process

Request for their data	No requirement for written request
Proof of ID	More detail?



13

Solicitors and others

- Valid approach
-  Need proof of ID from applicant
-  Need proof of consent



14

Powers of attorney

-  ICO guidance:
-  "it is reasonable to assume that an attorney with authority to manage the property and affairs of an individual has the appropriate authority to make a SAR on their behalf"
-  BUT Office of Public Guardian is more cautious

15

Public Guardian advice

-  **Am I satisfied that the person making the request:**
-  is acting in the best interests of the person concerned? needs the information to act properly?
-  will respect confidentiality?
will keep the information for no longer than necessary?

16

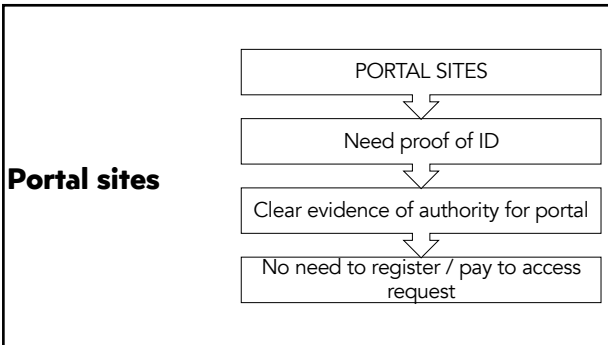

17

Process

	Request for their data	No requirement for written request
	Proof of ID	More detail?

18

CLOCK STOPS
(ICO u-turn)
If not clear if SAR is being made, clock does not start

19

FINAL GUIDANCE SAYS
You can ask the requester to provide additional details about the information they want to receive, such as the context in which you may have processed their information and the likely dates of when you processed it. **However, you cannot force an individual to narrow the scope of their request, as they are still entitled to ask for 'all the information you hold'** about them. If an individual responds to you and either repeats their request or refuses to provide any additional information, you must still comply with their request by making reasonable searches for the information.

20

GDPR Recital 63
Where the controller processes a large quantity of information concerning the data subject, the controller should be able to request that, before the information is delivered, the data subject specify the information or processing activities to which the request relates.

21

**TIME
LIMIT**

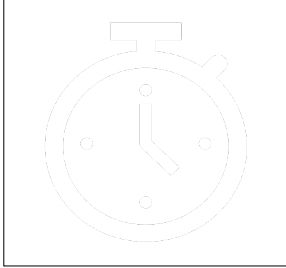

22

**TIME
LIMIT**

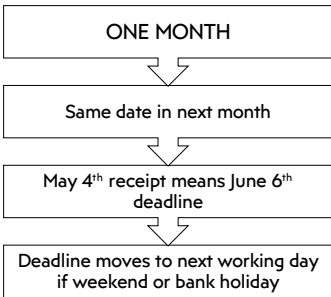

```
graph TD; A[ONE MONTH] --> B[Same date in next month]; B --> C[May 4th receipt means June 6th deadline]; C --> D[Deadline moves to next working day if weekend or bank holiday];
```

23

COMPLEX

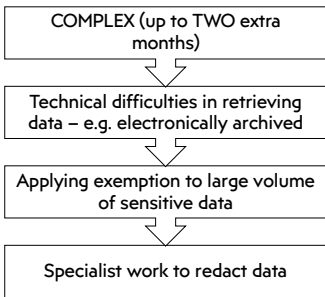

```
graph TD; A[COMPLEX (up to TWO extra months)] --> B[Technical difficulties in retrieving data - e.g. electronically archived]; B --> C[Applying exemption to large volume of sensitive data]; C --> D[Specialist work to redact data];
```

24

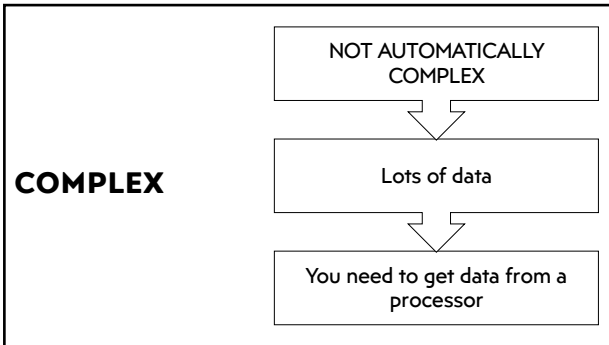

25

Unfounded / excessive

26

TWO OPTIONS

REFUSE

CHARGE FOR STAFF TIME

- Do you have data?
- Locating, retrieving and extracting
 - Providing copy
- Communicating the response to the individual

27

ICO ON UNFOUNDED

Applicant clearly has no intention to exercise their right of access

- e.g. an individual makes a request, but then offers to withdraw it in return for some form of benefit from the organisation

28

ICO ON UNFOUNDED

the request is malicious in intent and is being used to harass an organisation with no real purposes other than to cause disruption

- Applicant has explicitly stated that they intend to cause disruption
- Request makes unsubstantiated accusations
- Applicant is targeting a particular employee
- Applicant sends different requests as part of a campaign, e.g. once a week, intending to cause disruption

29

ICO ON EXCESSIVE

Request repeats substance of previous requests and reasonable interval has not elapsed or request overlaps with other requests

BUT

- Large amount of data?
- Second copy?
- Previous excessive or unfounded request?
- Overlapping request for different information?

30

Subject Access

31

Subject Access right (A15)	Personal data	Electronic response if subject wants	Purposes
	Categories of data	Recipients	Right to rectification / restriction
	Right to complain to ICO	Source of data	Existence of profiling and other automated processing

32

SAR PROCESS

Think about process

Who deals with the request?

How do you find the information?

Who makes the decisions?

33

SEARCHING

34

Given that subject access has been a feature of data protection law since the 1980s, your information management systems should facilitate dealing with SARs. They should enable you to easily locate and extract personal data and allow you to redact third-party data where necessary.

ICO final guidance, 2020

35

“reasonable and proportionate”
(Ezsias 2007)

“a reasonable and proportionate search” (Ittihadieh 2017)

“reasonable and proportionate”
(Holyoake 2017)”

36

REFUSAL



37

**ICO
Guidance
2020**

“if telling an individual that you have applied a particular exemption would prejudice the purpose of that exemption, your response may be more general. However, where possible, you should be transparent about your reasons for withholding information”



38

**Other
people
AKA
'mixed
requests'**

	DB v GMC [2018] EWCA Civ 1497
	Report into GP's competence, requested by patient whose bladder cancer was missed. GMC want to disclose to patient
	No presumption that consent is needed: controller decides

39

Other people exemption

-  **DPA 2018; Schedule 2, Part 3, para 16**
-  You can withhold data about other data subjects to be withheld from a SAR
-  **EXCEPT**
Consent
Reasonable in all circumstances to disclose





40

Take into account

-  What sort of data it is (e.g. how sensitive)
-  Whether data is confidential
-  Whether you've tried to get consent
Can other person give consent
Has person has explicitly withheld consent?





41

DPA 2018, Schedule 2, Part 1, Para 2

-  Crime prevention / detection
-  Apprehension / prosecution of offenders
-  Assessment / collection of taxes
-  Only if purpose is prejudiced

42

**DPA 2018,
Schedule
2, Part 1,
Para 5**

-  Mandatory disclosures
-  Disclosures required by enactment, rule of law or court order if provisions would prevent controller from disclosing
-  Or where disclosure of the data is necessary--
-  (a) for legal proceedings (including prospective legal proceedings)
-  (b) obtaining legal advice or otherwise establishing, exercising or defending legal rights





43

**DPA 2018,
Schedule 3,
Part 2, para 5**

Health	
Subject access exemption	Serious harm to the mental or physical health of any individual
Need opinion of health professional	Can disclose data that subject already knows

44

**DPA 2018,
Schedule
2, Part 4**

-  19: Legal professional privilege
-  22: Management forecasting
-  23: Negotiations
-  24: Confidential references in education, training, employment etc (given or received)
-  25: Exam scripts and results

45



46



47



48



49

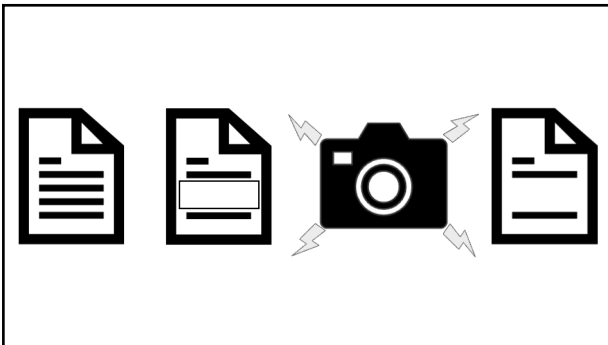

50

Redaction

-  **REMOVE: DON'T HIDE**
-  Think about properties / metadata
-  Think about hidden fields and embeds
-  Changing format usually works

51

OTHER RIGHTS

52

A16: Rectification

- Rectification of inaccurate data
- Incomplete data should also be completed, including by means of a supplementary statement
- A18: Restriction**
- Data should be "at least" marked as unavailable
- This may need to go further (e.g. restricted access)

53

Accuracy

Tim Turner is bald

Tim Turner has a tattoo of the ICO logo on his forehead

Tim Turner is a confrontational show-off

Tim Turner was diagnosed with Tachycardia and is being treated with medication

54

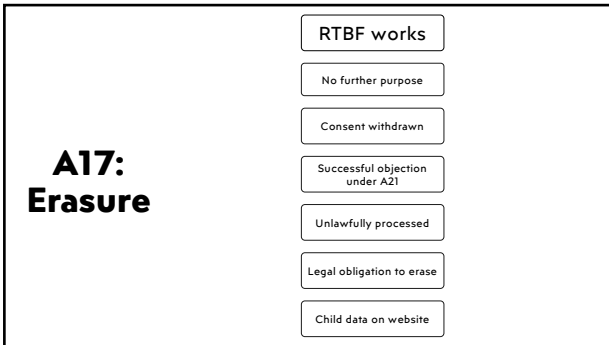

55

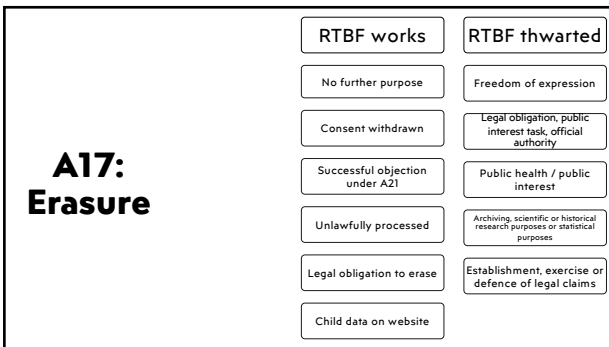

56

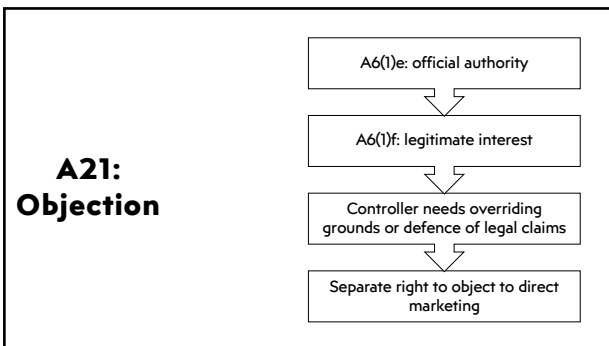

57

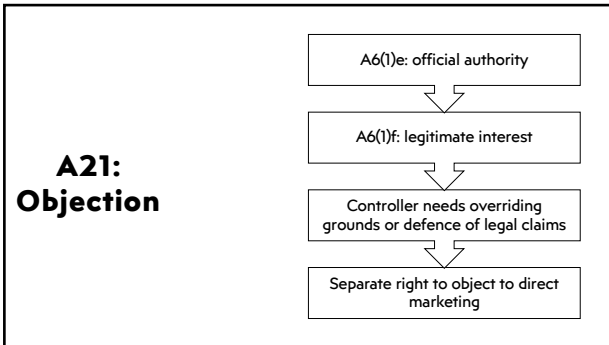

58

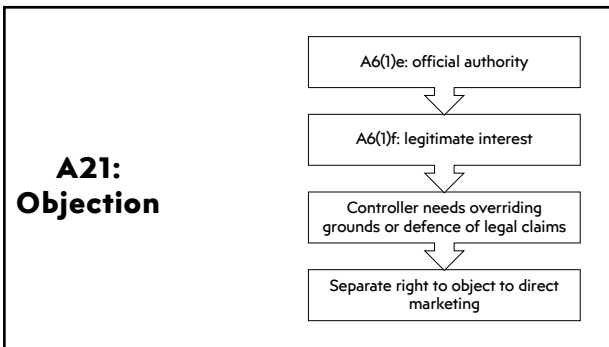

59

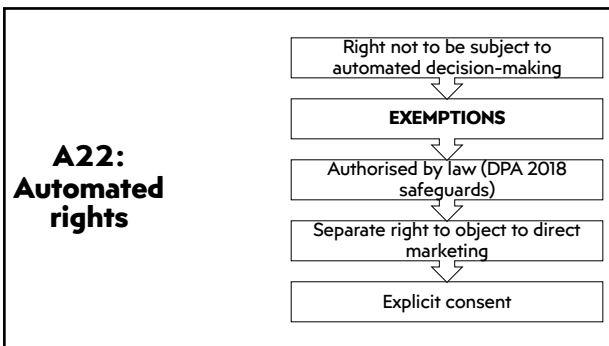

60

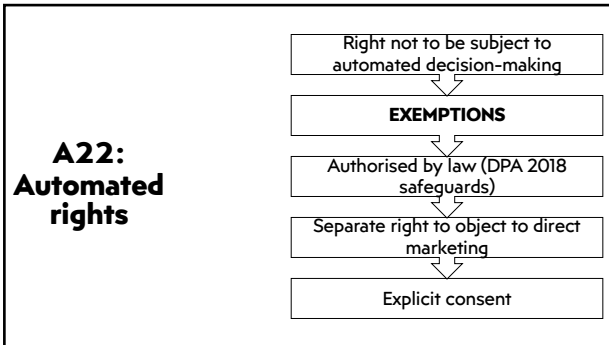

61

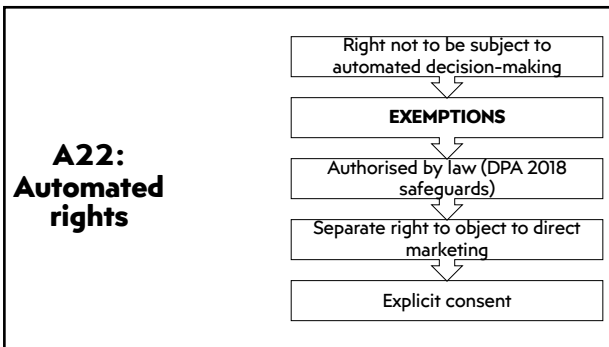

62

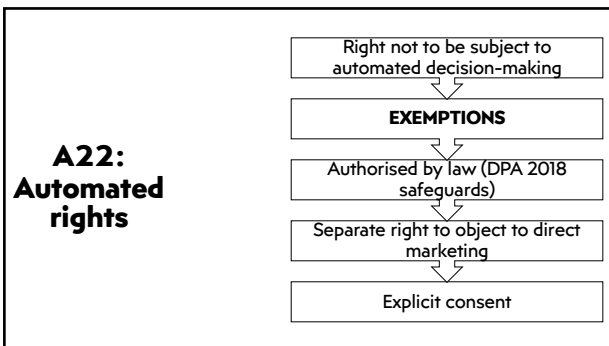

63

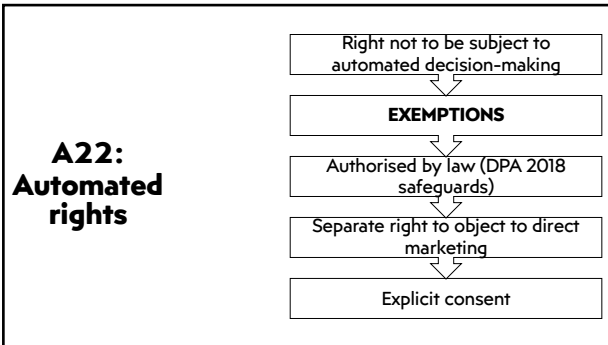

64

DPA safeguards

S14: Significant automated decisions authorised by law

Must tell person that decision has been made

Give them opportunity to challenge

Must reconsider decision or take new non-automated decision

65

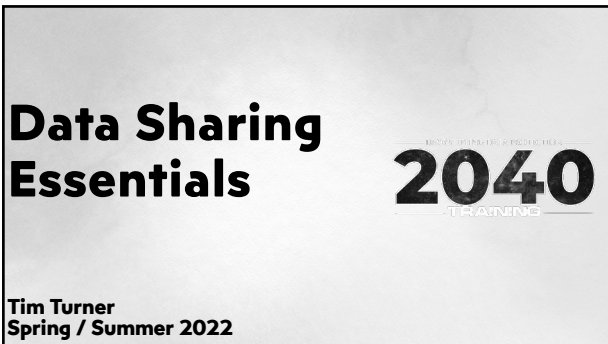

66

Data sharing risks

67

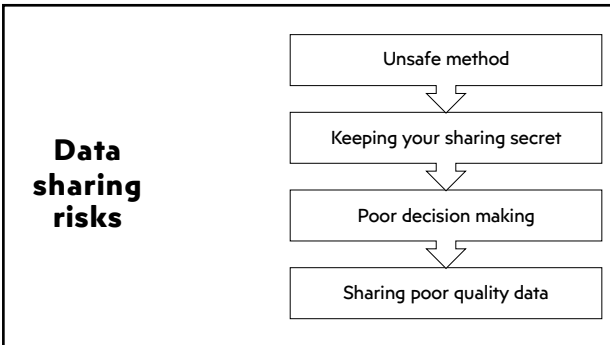

68

Terminology

Data Sharing

69

Terminology

'processing' means any operation or set of operations which is performed on personal data or on sets of personal data, whether or not by automated means, such as collection, recording, organisation, structuring, storage, adaptation or alteration, retrieval, consultation, use, disclosure by transmission, dissemination or otherwise making available, alignment or combination, restriction, erasure or destruction

70

Terminology

~~Data Sharing~~

Disclosure

71

**GET
READY**

Routine,
regular
disclosures

Ad hoc
disclosures

72

Think about a situation where your org discloses data

73

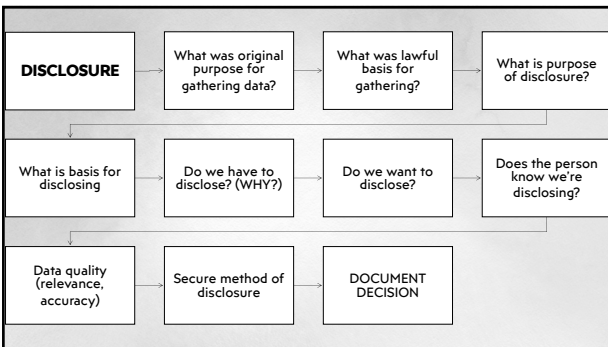

74

Define disclosure purpose

75

Identify lawful basis to process data

76

Lawful basis

Consent	Necessary for contract	Necessary for legal obligation
Necessary to protect vital interests	Necessary for official authority / public interest	Necessary for legitimate interest

77

Special categories exemptions

Explicit consent	Employment law	Vital interests no consent	Special category group use
Made public by subject	Substantial public interest	Establish / defend legal claims	Health / social care
Public health	Archiving / research with safeguards		

78

**Do you need
to do a data
protection
impact
assessment?**

79



80

**Do we need a
data sharing
agreement?**

81

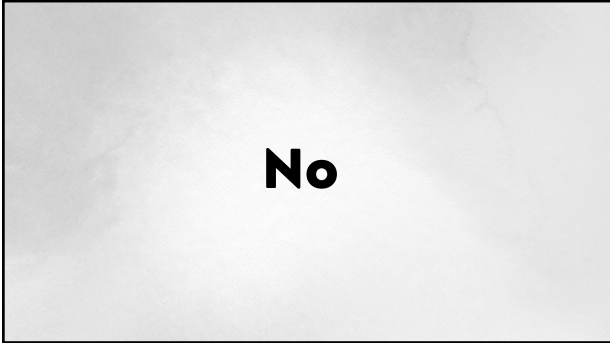

82



83

Data sharing agreements

- Roles
- Purpose and lawful basis
- How data should be disclosed + to whom
- Secure methods of transfer
- What triggers a disclosure?
- Accuracy
- Compatibility
- Meets A26 joint controller's requirement

84

**Do we have
to tell people
about the
disclosure?**

85

Yes

86

Yes (except)...

87

Data quality

88

Shared databases

89

Shared databases

- What data is needed and why
- Consistency
- Purposes outside the system
- Access control and revocation of rights

90

Ad hoc disclosures

91

Staff member gets unexpected request

Same basic questions

Purpose / lawful basis?

Right data?

Right method for sharing?

92

Decision-making

Use your judgement?

Escalate to someone else?

Properly communicated?

93

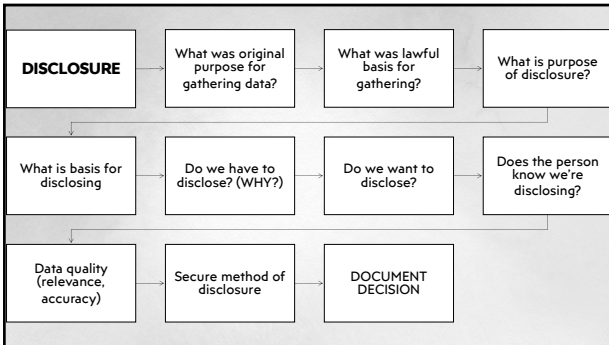

94

A police officer phones your organisation asking for confirmation that two named employees were logged in at work on three specific dates, and what their home addresses are

95

Contact me for more

2040
TRAINING

Tim Turner
Tel: 07508341090
Email: tim@2040training.co.uk
www.2040training.co.uk

96